

Varenummer: 4320000801
Beskrivelse: Rota-fix spændelement A 80x120
Rustfast stål

Mål

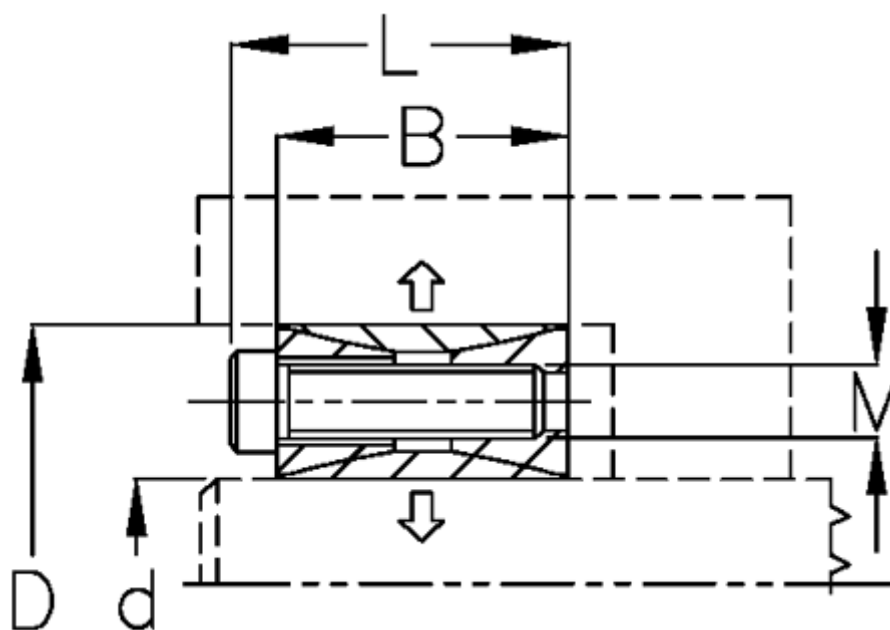

B mm	= 28
d H8 mm	= 80
D mm	= 120
F kN aksialkraft	= 83.6
L mm	= 38
M mm	= M10
Overfladeruhed	= R? ? 3.2 μ m
P N/mm ² fladetryk på aksel/nav	= 47

T Nm drejningsmoment	= 3300
Tolerance	= Aksel k11-h11, Nav M10
Ts Nm boltetilspændingsmoment	= 44.0